

Wydanie <i>Edition</i>	01
Data <i>Date</i>	15-01-2018

## ZAMEK 9 CASTLE 9

Numer katalogowy  
*catalogue number* **83009**

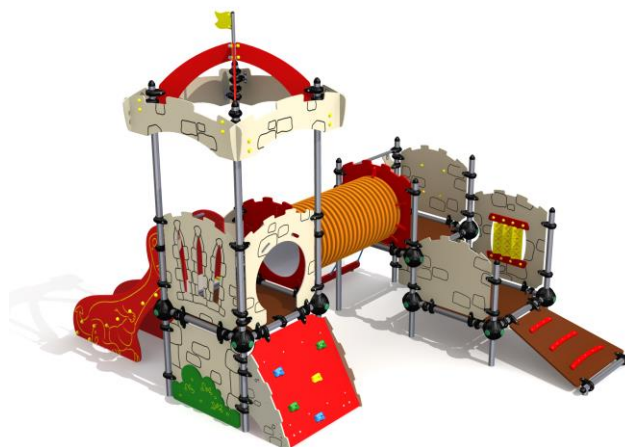





### 1. Informacje techniczne *Technical information*

Grupa wiekowa <i>User age</i>	do 14 lat
Maksymalna wysokość swobodnego upadku <i>Max. free fall height</i>	0,93 m
Największa część <i>Largest part</i>	Zjeżdżalnia <i>Slide</i>
Wymiary największej części <i>Largest part dimensions</i>	1,76 x 1,61 x 0,53 m
Masa największej części <i>Largest part weight</i>	70 kg
Masa największego fundamentu <i>Largest foundation weight</i>	60 kg
Zgodność z normami <i>Accordance with standards</i>	EN 1176-1:2008 EN 1176-3:2008

## 2. Wykaz narzędzi

### Tools list

					
			 x2		

## 3. Wykaz części

### Parts list

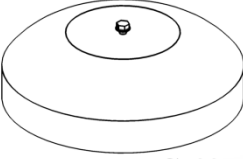
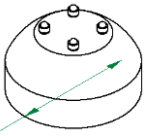
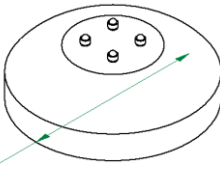
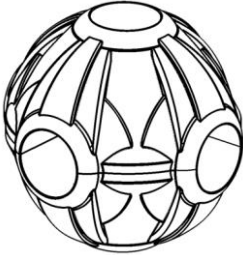
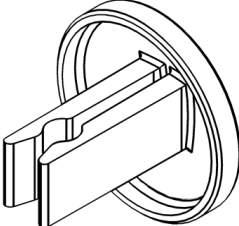
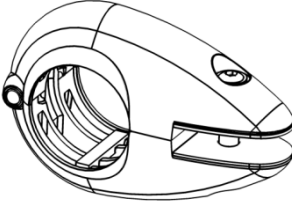
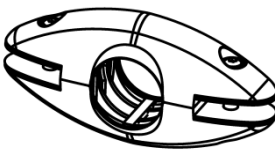
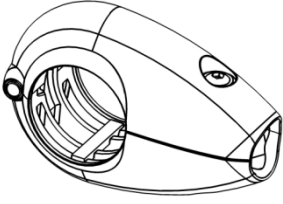
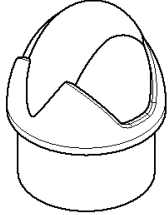
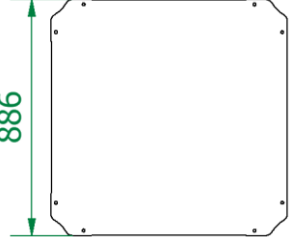
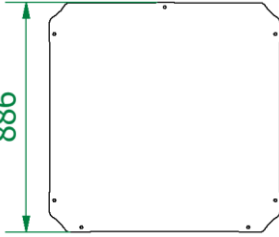
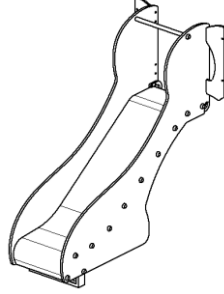

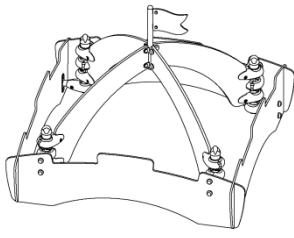
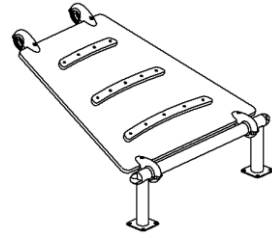
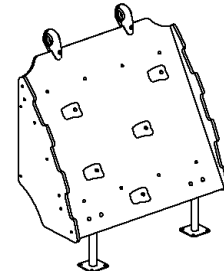
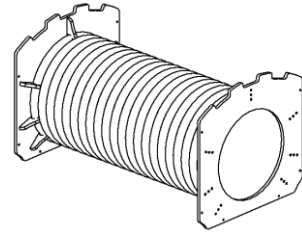
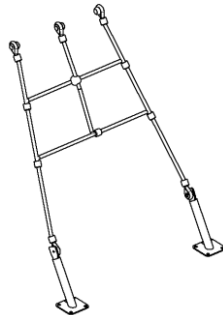
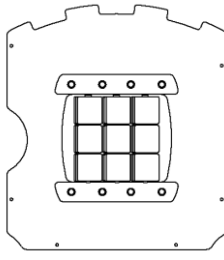
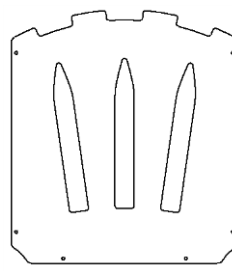
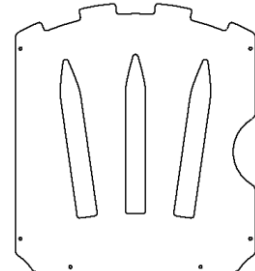
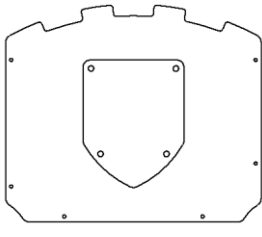
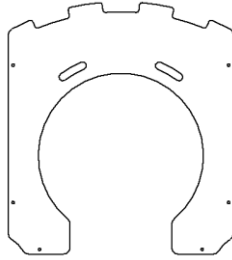
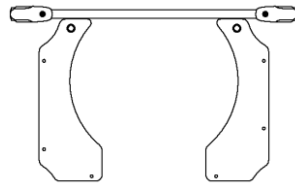
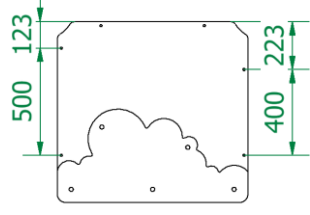
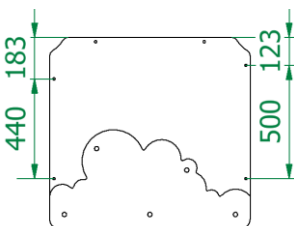
 Ø500	 Ø300	 Ø500	
B500x1	Szt. Pcs 1	B300x4	Szt. Pcs 12
			
ZS-1	Szt. Pcs 24	UC-1*	Szt. Pcs 91
	 886	 886	
ZS-2	Szt. Pcs 12	PK-1000*	Szt. Pcs 2
		PK-1000-B	Szt. Pcs 1
		ZJ	Szt. Pcs 1

											
D4	Szt. Pcs	1	TRP	Szt. Pcs	1	WW	Szt. Pcs	1	TUN	Szt. Pcs	1
											
WL	Szt. Pcs	1	XO	Szt. Pcs	1	BAR-A1	Szt. Pcs	1	BAR-D5	Szt. Pcs	1
											
BAR-N-A2	Szt. Pcs	1	PRZ-A4	Szt. Pcs	1	PRZ-A1-A6	Szt. Pcs	1	PLT-A5	Szt. Pcs	1
											
PLT-A6	Szt. Pcs	1									

\* patrz – instrukcja szczegółowa  
see – detailed instruction

#### 4. Rury

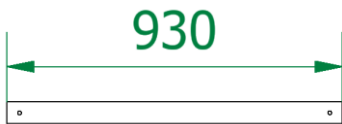
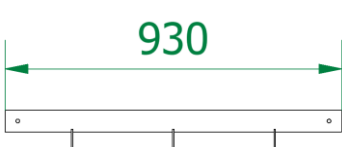
pipes

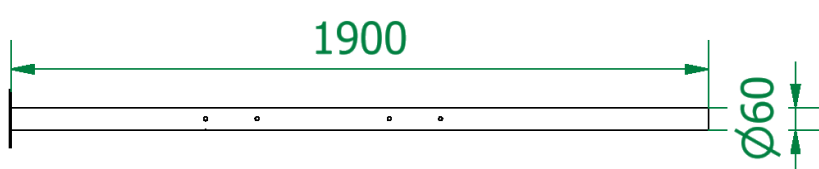
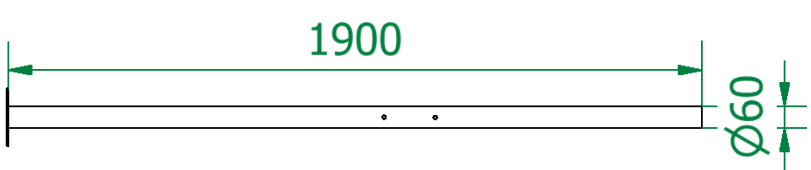
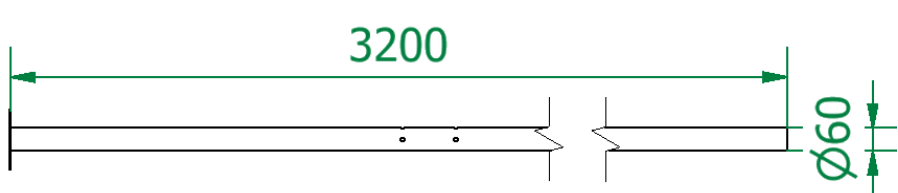
RO-1	Szt./Pcs	11	
			
RO-2	Szt./Pcs	1	
			
RO-3	Szt./Pcs	2	
			
RO-4	Szt./Pcs	2	
			
RO-5	Szt./Pcs	2	
			
RO-6	Szt./Pcs	4	
			

## 5. Etapy instalacji

### Installation steps

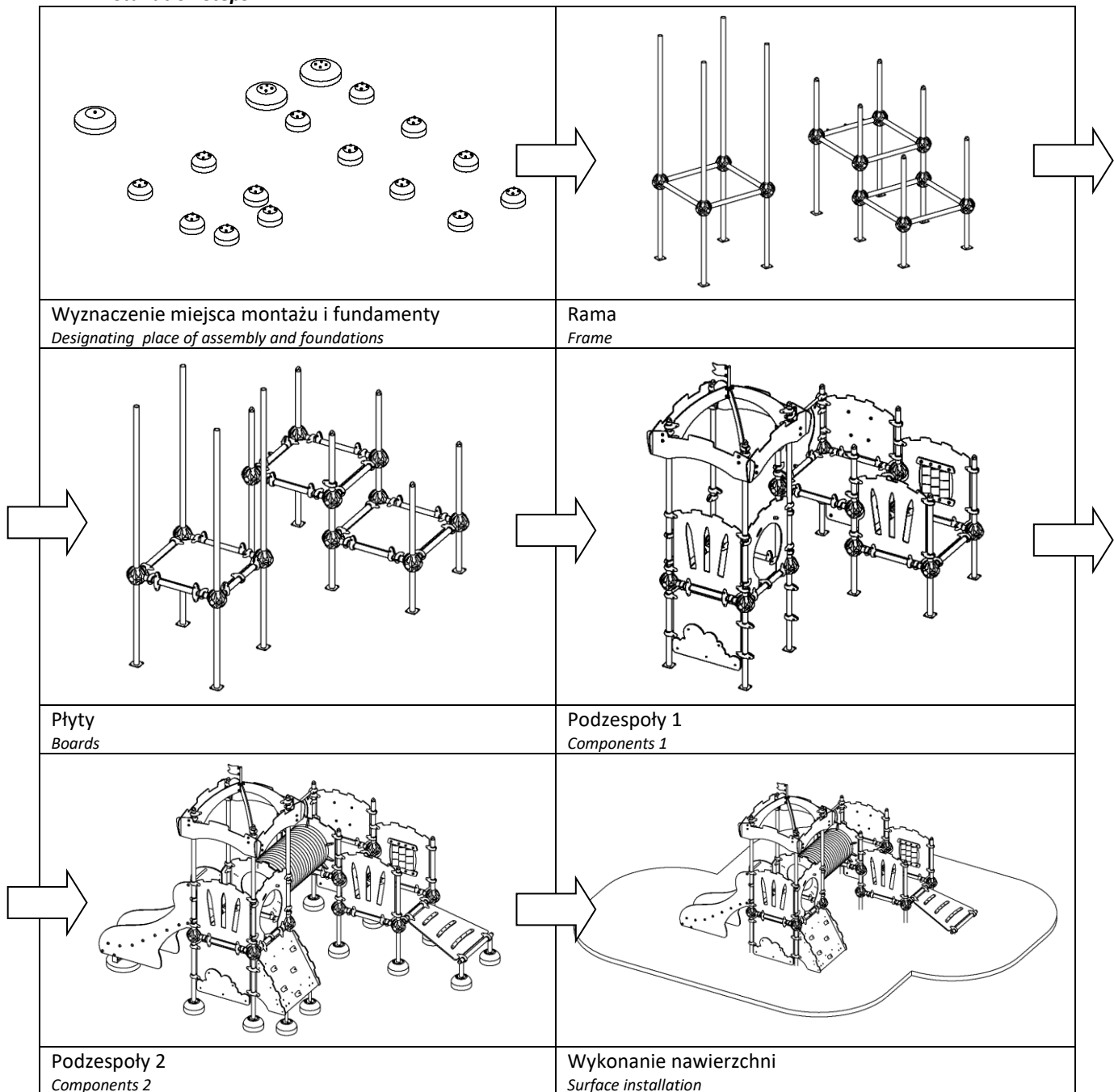

## 6. Fundamenty i powierzchnia zderzenia

*Foundations and impact area*

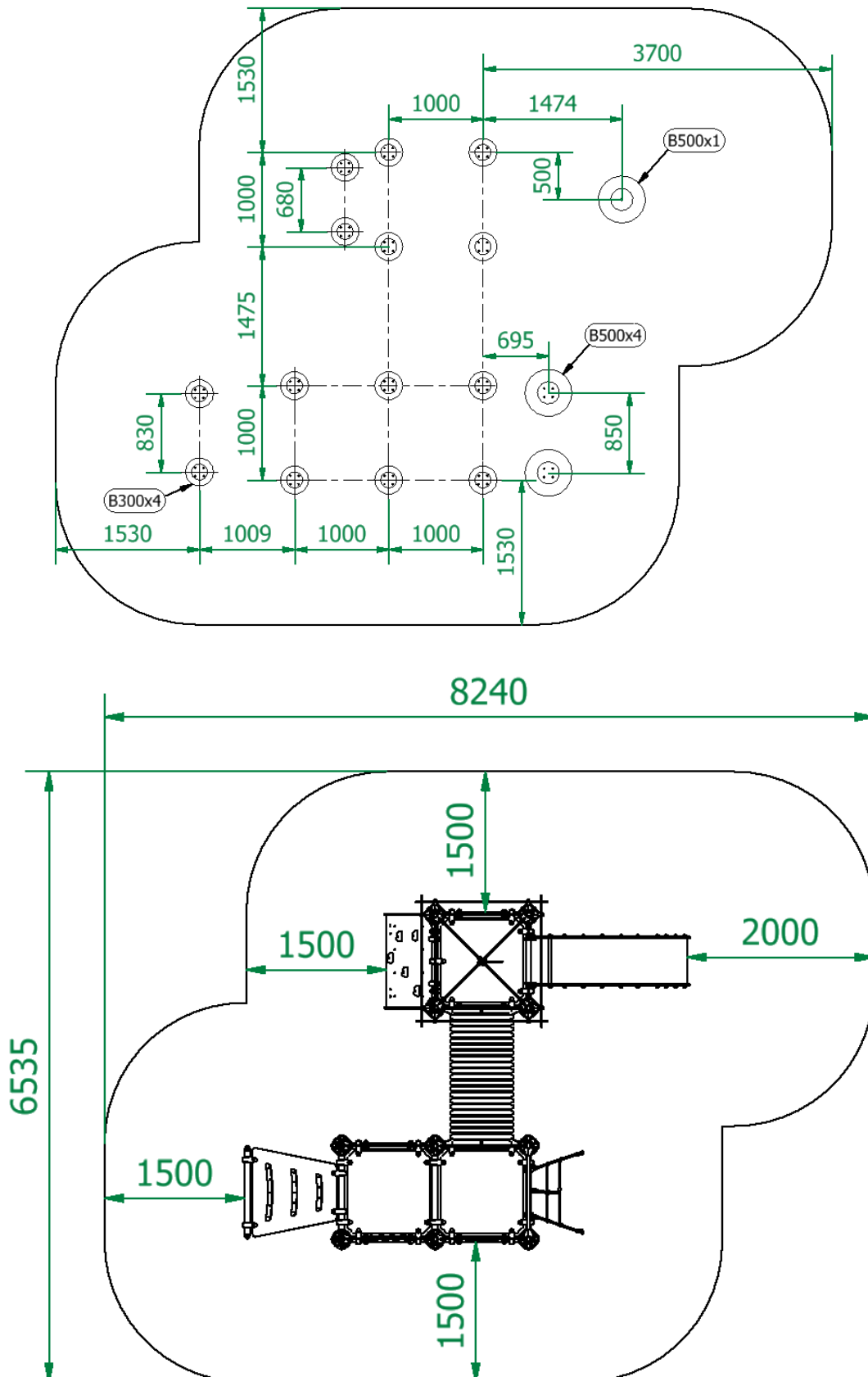

**7. Rama**  
*Frame*

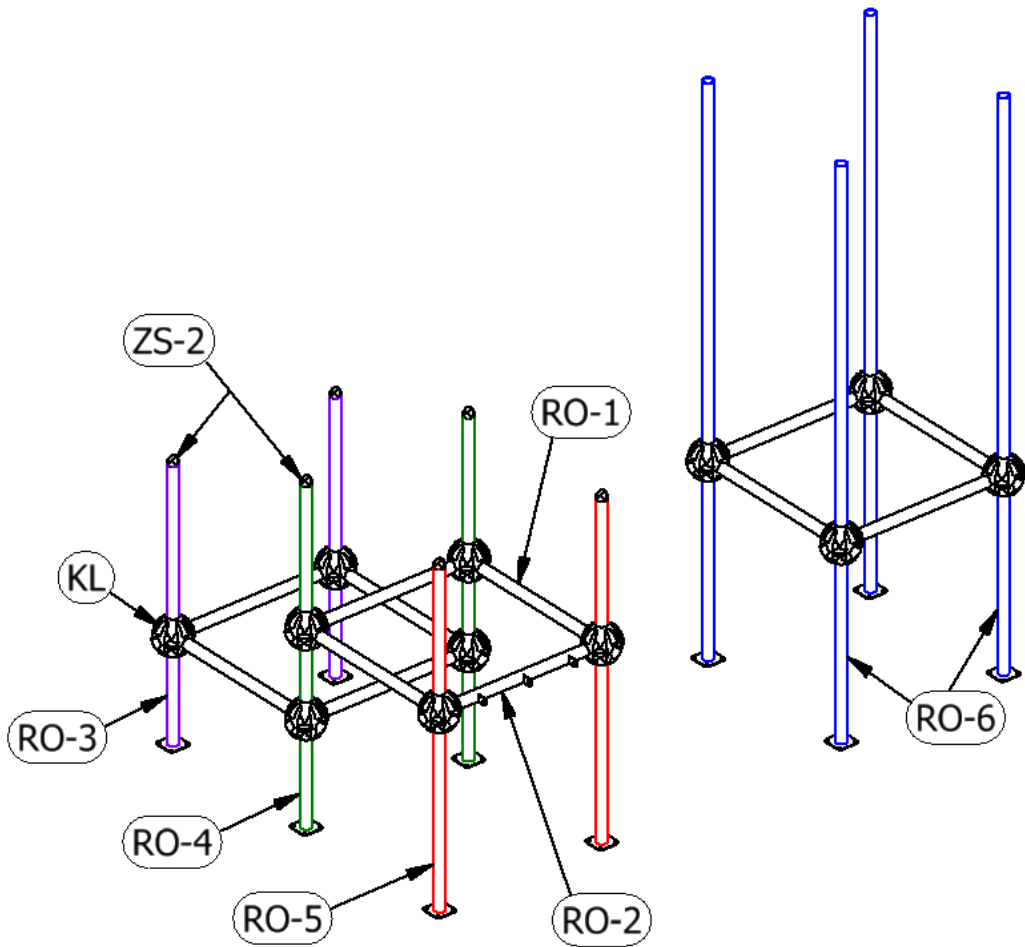
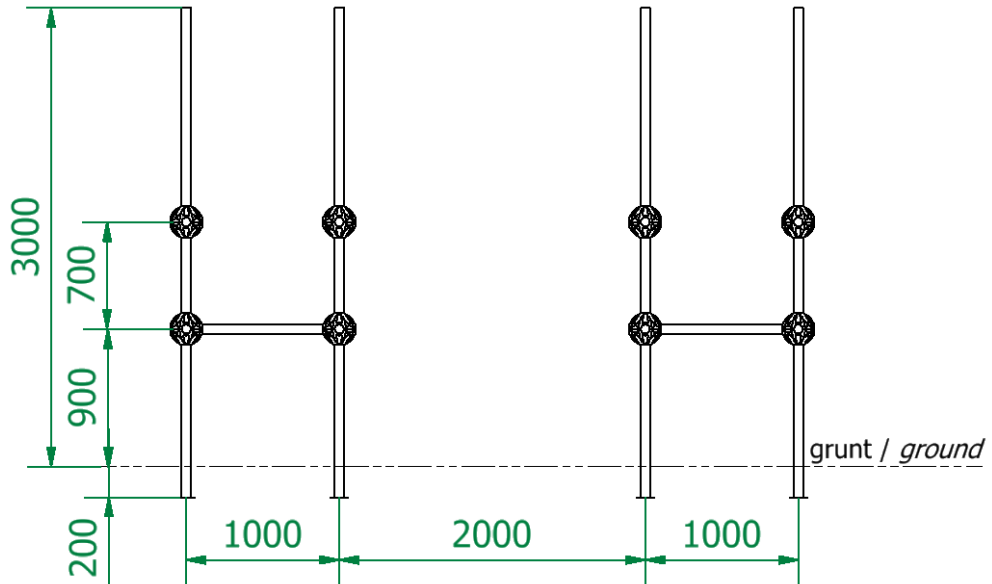

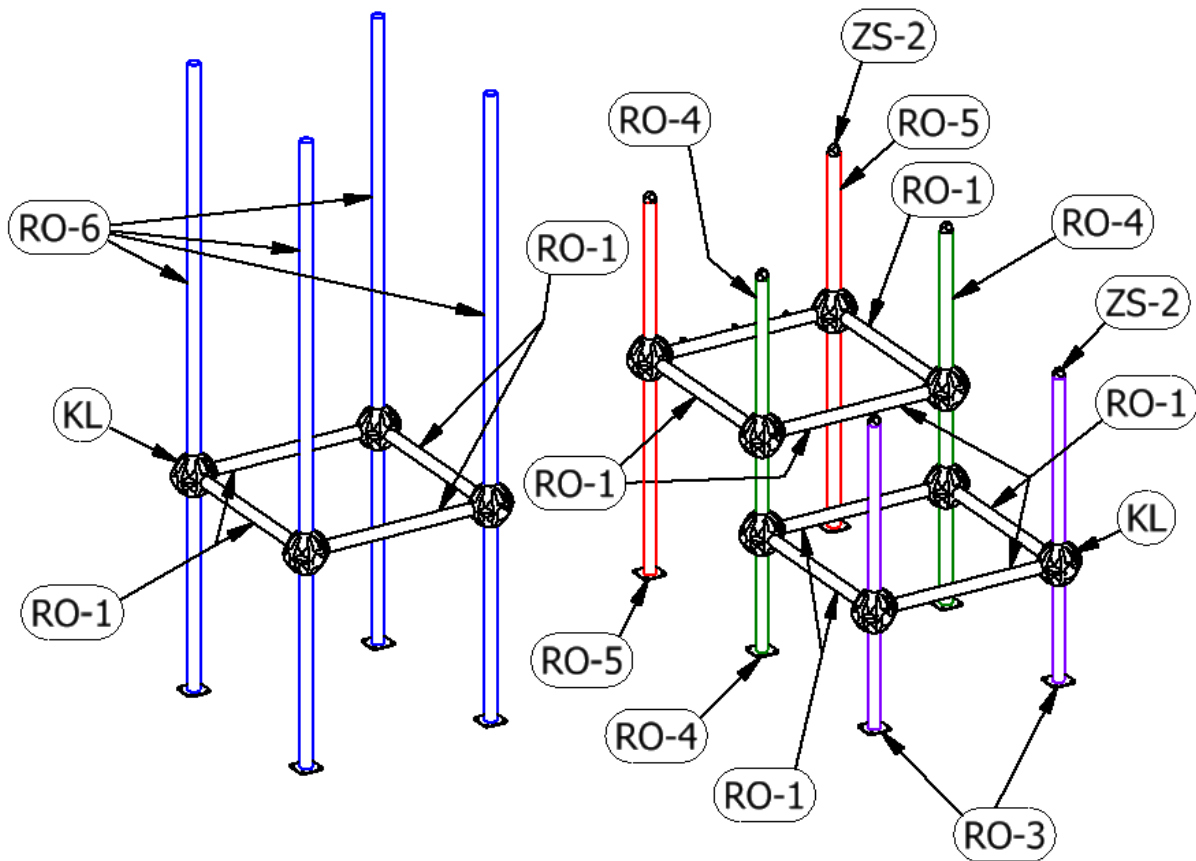

## 8. Płyty Boards

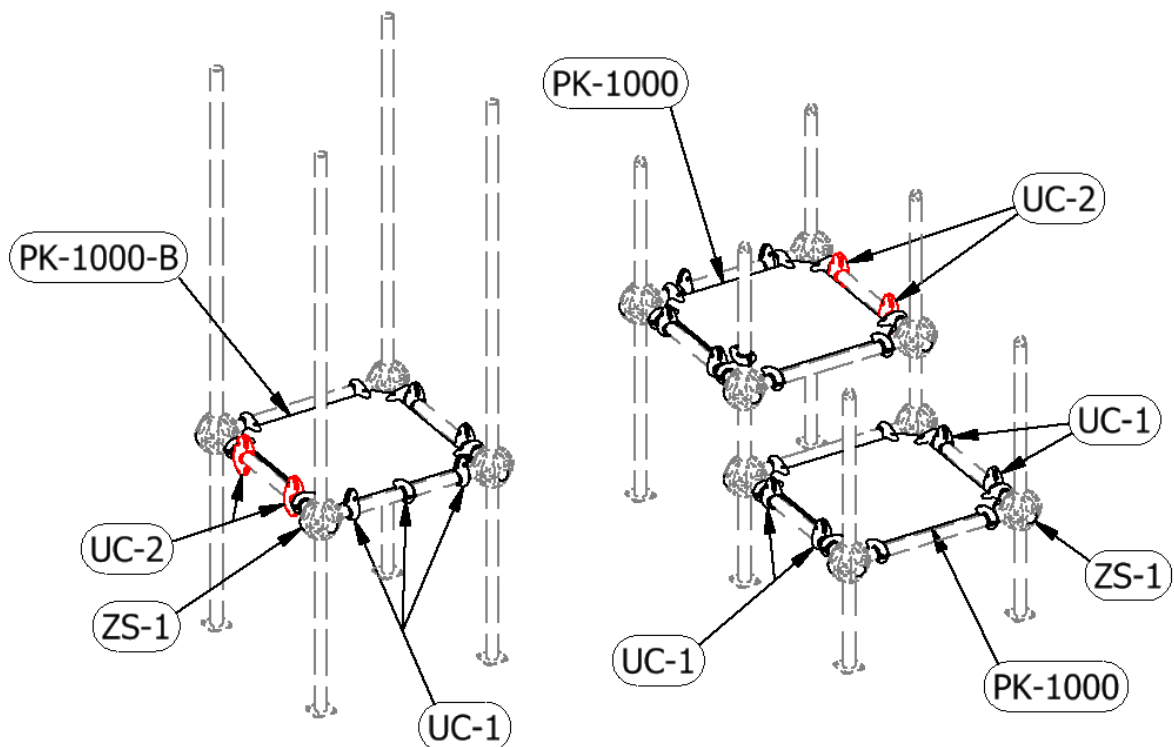

Zalecane wstępne nałożenie uchwytów (bez dokręcania) / Recommended initial assembly of holders (without tightening)



## 9. Podzespoły Components

